

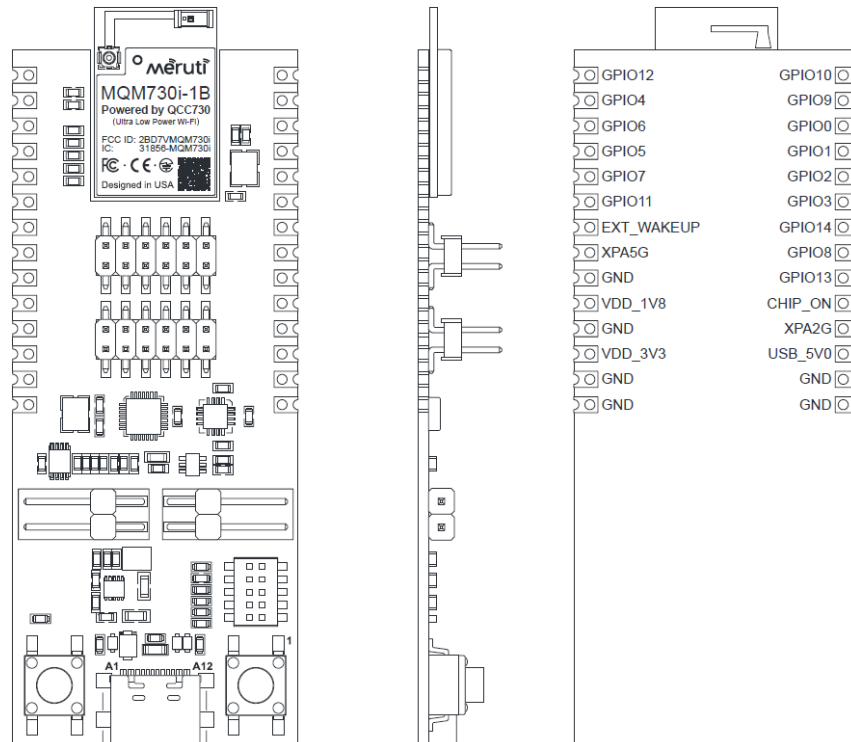

Qualcomm QCC730 Module Development Kit

March 2024



Documentation Title	Documentation No	Revision	Classification	Status	Date
Qualcomm QCC730 Module Development Kit User Manual		V2.0	Public	Release	Mar 31, 2024

Table of Contents

1	Overview	3
2	Package	4
3	Hardware	5
3.1	Block Diagram	5
3.2	Functional Description	5
3.2.1	Power Supply	5
3.2.2	Power Measurement	5
3.2.3	Debug	6
3.2.4	Reset	6
3.2.5	Headers.....	6
3.2.6	Pin Definition	7
3.3	Component Layout	8
3.4	Jumper Setting	8
3.5	Mechanical Dimension	9
3.6	Schematic	11
4	Software	12
5	Integrated Development Environment (IDE)	13
5.1	Microsoft Visual Studio Code (VS Code)	13
5.2	VS Code IDE Functional Description	13
6	Order Information	15
7	Where to Buy	16

Documentation Title	Documentation No	Revision	Classification	Status	Date
Qualcomm QCC730 Module Development Kit User Manual		V2.0	Public	Release	Mar 31, 2024

1 Overview

Powered by Qualcomm QCC730, Qualcomm QCC730 module development kit (“DevKit”) is purposely-designed for application software developers with developer first mindset. The DevKit exposes all QCC730 GPIO pins via QCC730 module to dual 2.54mm (0.1inch) headers to allow flexible expansion. Developers can easily add sensors and other accessories through these dual headers. The dual header is designed to have width of 25.4mm (1.0inch) to allow easy plug-in to the widely used breadboard further to facilitate prototyping development.

The QR code is provided on the back of the DevKit to allow developers to obtain this user manual online.



Figure 1: QCC730 Module Development Kit QR Code

The DevKit 3-side view is shown below:

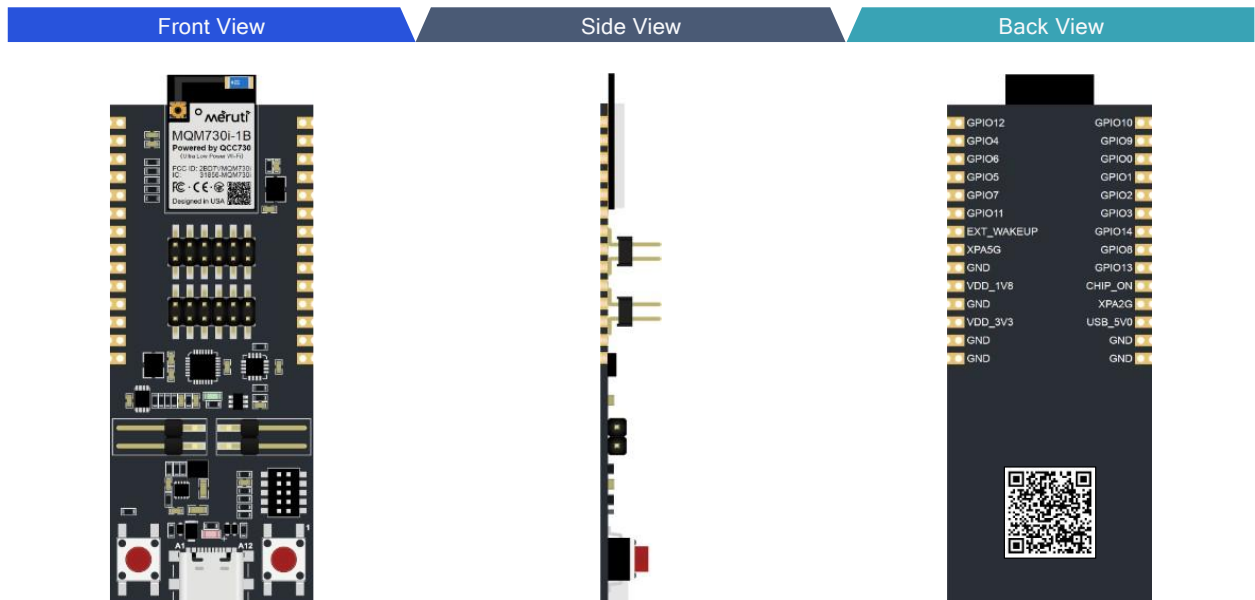

Figure 2: QCC730 Module Development Kit View

Documentation Title	Documentation No	Revision	Classification	Status	Date
Qualcomm QCC730 Module Development Kit User Manual		V2.0	Public	Release	Mar 31, 2024

2 Package

Included with the DevKit are a pair of male and a pair of female headers to allow developers to have flexibility to mate into their expansion boards.

The DevKit package content is shown below:

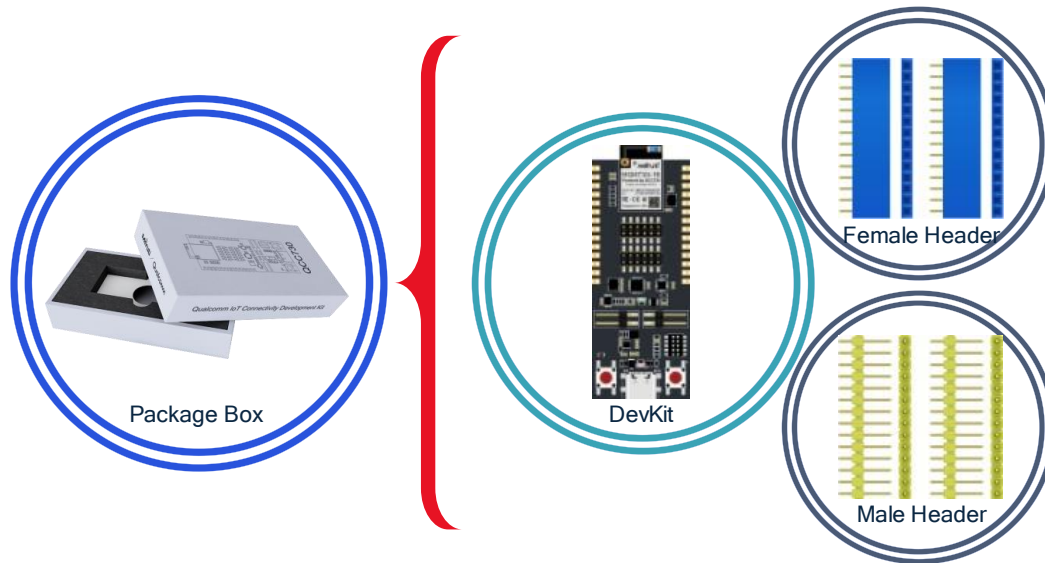

Figure 3: QCC730 Module Development Kit Packaging

Documentation Title	Documentation No	Revision	Classification	Status	Date
Qualcomm QCC730 Module Development Kit User Manual		V2.0	Public	Release	Mar 31, 2024

3 Hardware

3.1 Block Diagram

The DevKit block diagram is shown below:

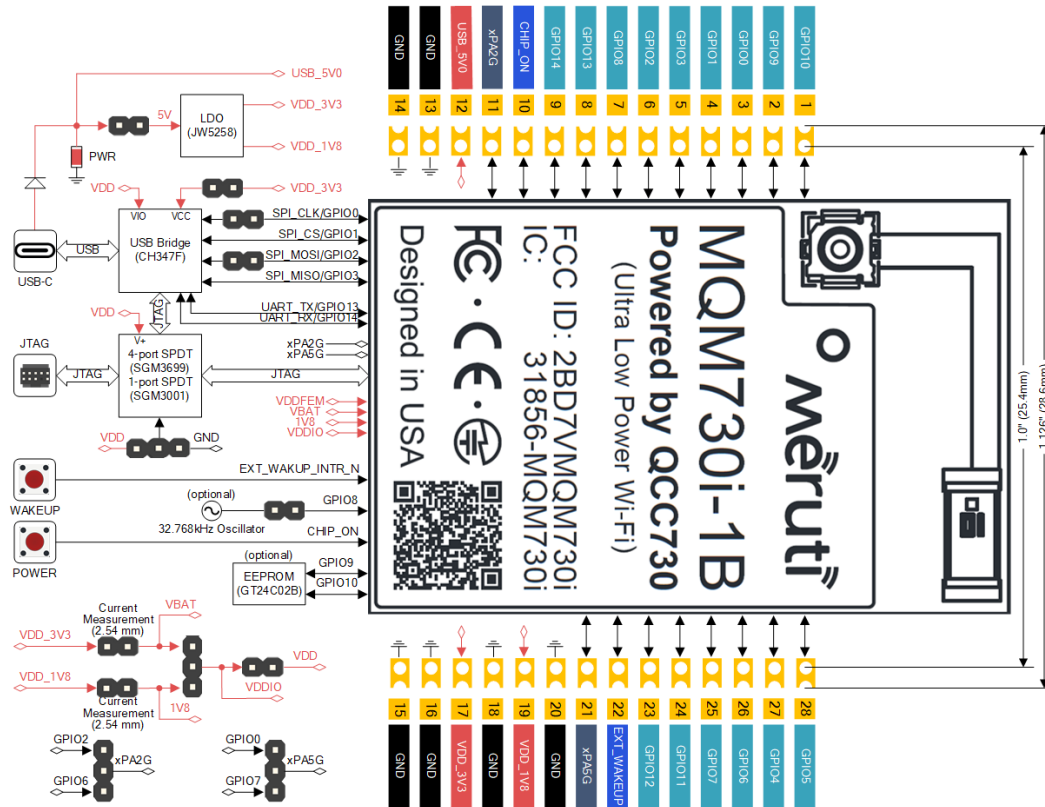

Figure 4: QCC730 Module Development Kit Block Diagram

3.2 Functional Description

3.2.1 Power Supply

The DevKit can be powered from USB-C by plugging into PC. The on-board LDO can convert USB-C 5V into 3.3V and 1.8V. The DevKit input and I/O voltage can be selected from either 3.3V or 1.8V. These 3.3V and 1.8V are also pulled to the DevKit header pins to power expansion boards attached to the DevKit.

The DevKit can also be powered from battery pack which can be plugged into the DevKit headers. The power from USB-C can be de-selected removing the jumper. The battery pack power can be supplied through VDD_3V3 and VDD-18V on the DevKit headers.

3.2.2 Power Measurement

Both 3.3V and 1.8V power rails on QCC730 module power consumption can be measured through the on-board jumper by connecting to an external current measurement device.

Documentation Title	Documentation No	Revision	Classification	Status	Date
Qualcomm QCC730 Module Development Kit User Manual		V2.0	Public	Release	Mar 31, 2024

3.2.3 Debug

The DevKit supports SEGGR J-Link and OpenOCD. The on-board analog switch allows to developers to choose QCC730 module JTAG to go through SEGGR J-Link or thru USB-C connected to PC. The on-board USB to UART/JTAG bridge allows both JTAG and UART populated on the PC device manager. Developers can use OpenOCD and UART simultaneously.

3.2.4 Reset

The on-board POWER button allows developers to power on the DevKit.

3.2.5 Headers

Dual standard 2.54mm (0.1inch) headers with 12-pin each side is created on the DevKit to allow developers to attach to any expansion boards of their choice.

The pin map is shown below:

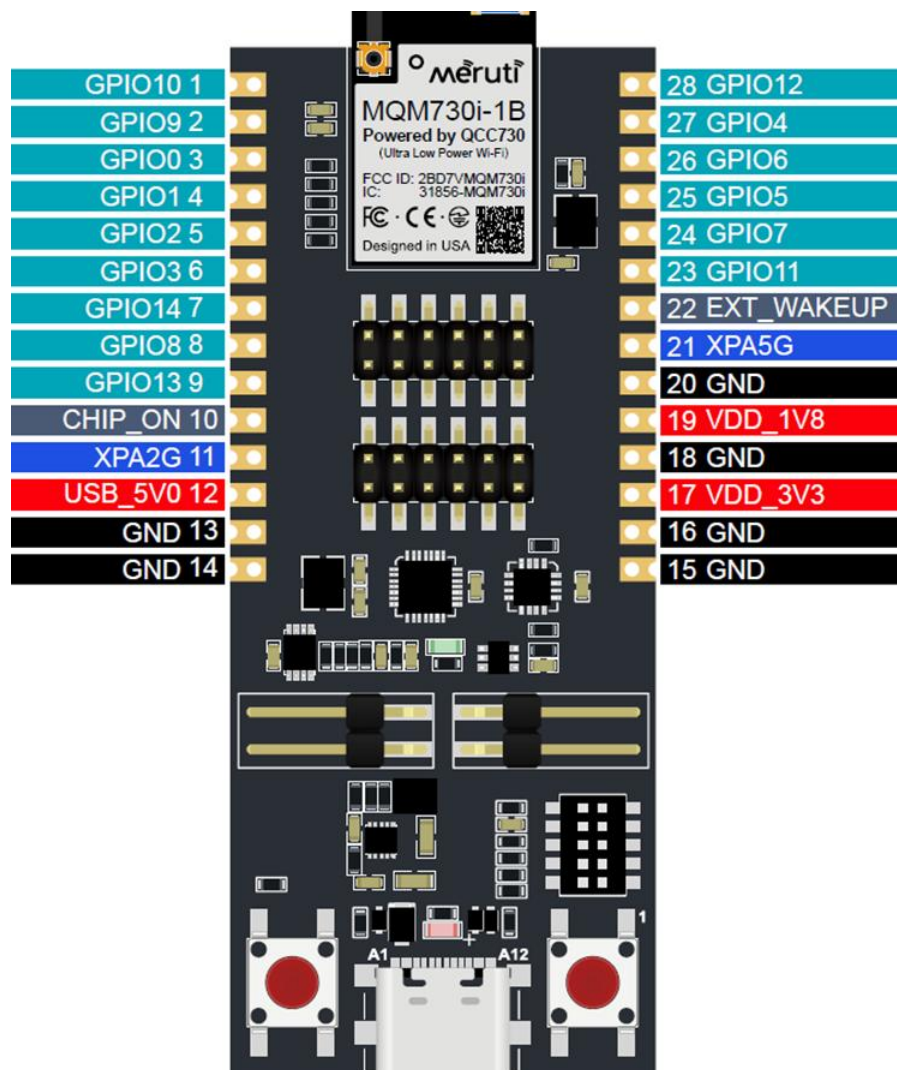

Figure 5: QCC730 Module Development Kit Pin Map

Documentation Title	Documentation No	Revision	Classification	Status	Date
Qualcomm QCC730 Module Development Kit User Manual	V2.0	Public	Release	Mar 31, 2024	

3.2.6 Pin Definition

Pin	Pin Name	Type	Power Domain	Description
11	VDD_5V0	PWR	-	5.0V from USB-C
14	VDD_3V3	PWR	-	3.3V from on-board LDO or external battery
16	VDD_1V8	PWR	-	1.8V from on-board LDO or external battery
12,13,17	GND	GND	-	Ground
18	EXT_WAKEUP	DI	-	External interrupt input
10	CHIP-ON	DI	-	Chip power on
3	GPIO0	DI/DO	VDDIO	Generic PIO
4	GPIO1	DI/DO	VDDIO	Generic PIO
5	GPIO2	DI/DO	VDDIO	Generic PIO
6	GPIO3	DI/DO	VDDIO	Generic PIO
23	GPIO4	DI/DO	VDDIO	Generic PIO
21	GPIO5	DI/DO	VDDIO	Generic PIO
22	GPIO6	DI/DO	VDDIO	Generic PIO
20	GPIO7	DI/DO	VDDIO	Generic PIO
8	GPIO8	DI/DO	VDDIO	Generic PIO
2	GPIO9	DI/DO	VDDIO	Generic PIO
1	GPIO10	DI/DO	VDDIO	Generic PIO
19	GPIO11	DI/DO	VDDIO	Generic PIO
24	GPIO12	DI/DO	VDDIO	Generic PIO
9	GPIO13	DI/DO	VDDIO	Generic PIO
7	GPIO14	DI/DO	VDDIO	Generic PIO

Documentation Title	Documentation No	Revision	Classification	Status	Date
Qualcomm QCC730 Module Development Kit User Manual		V2.0	Public	Release	Mar 31, 2024

3.3 Component Layout

Jumpers and button are purposely designed and defined to allow flexible configurations and operations. The DevKit component layout is illustrated below:

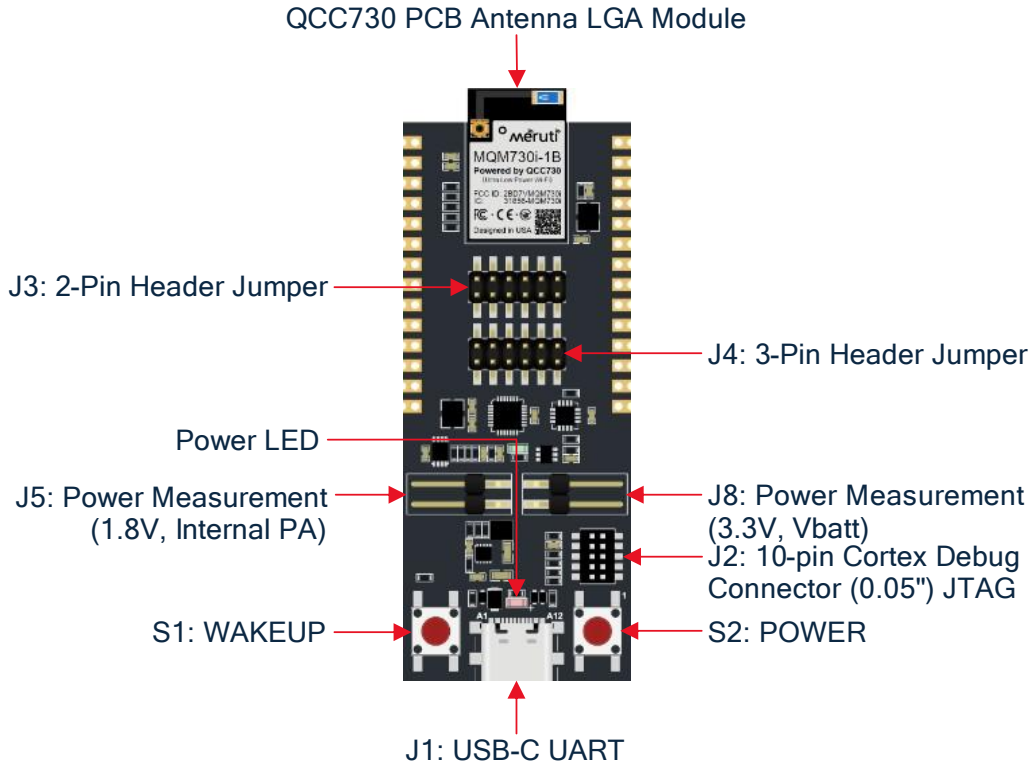

Figure 6: QCC730 Module Development Kit Component Layout

3.4 Jumper Setting

The DevKit jumper definition is illustrated below:

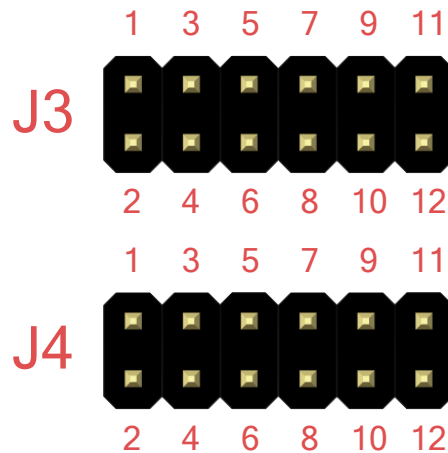

Figure 7: QCC730 Module Development Kit Jumper Setting

Documentation Title	Documentation No	Revision	Classification	Status	Date
Qualcomm QCC730 Module Development Kit User Manual		V2.0	Public	Release	Mar 31, 2024

Each individual jumper setting is defined in the table below:

Jumper	Pin 1	Pin 2	Function
J3 (2-pin Jumper)	1	2	USB 5V power supply enable
	3	4	USB to UART bridge (CH347F) VDD power-on
	5	6	USB to UART bridge (CH347F) power-on
	7	8	GPIO2 connect enable
	9	10	GPIO0 connect enable
	11	12	32.768kHz oscillator (GPIO8) connect enable
J4 (3-pin Jumper)	1	3	VDDIO selection 1.8V
	3	5	VDDIO selection 3.3V
	7	9	10-pin Cortex debug JTAG
	9	11	USB-C debug OpenOCD
	2	4	XPG2G control GPIO2
	4	6	XPG2G control GPIO6
	8	10	XPG5G control GPIO0
	10	12	XPG5G control GPIO7

3.5 Mechanical Dimension

The DevKit mechanical dimension is shown below:

Documentation Title	Documentation No	Revision	Classification	Status	Date
Qualcomm QCC730 Module Development Kit User Manual		V2.0	Public	Release	Mar 31, 2024

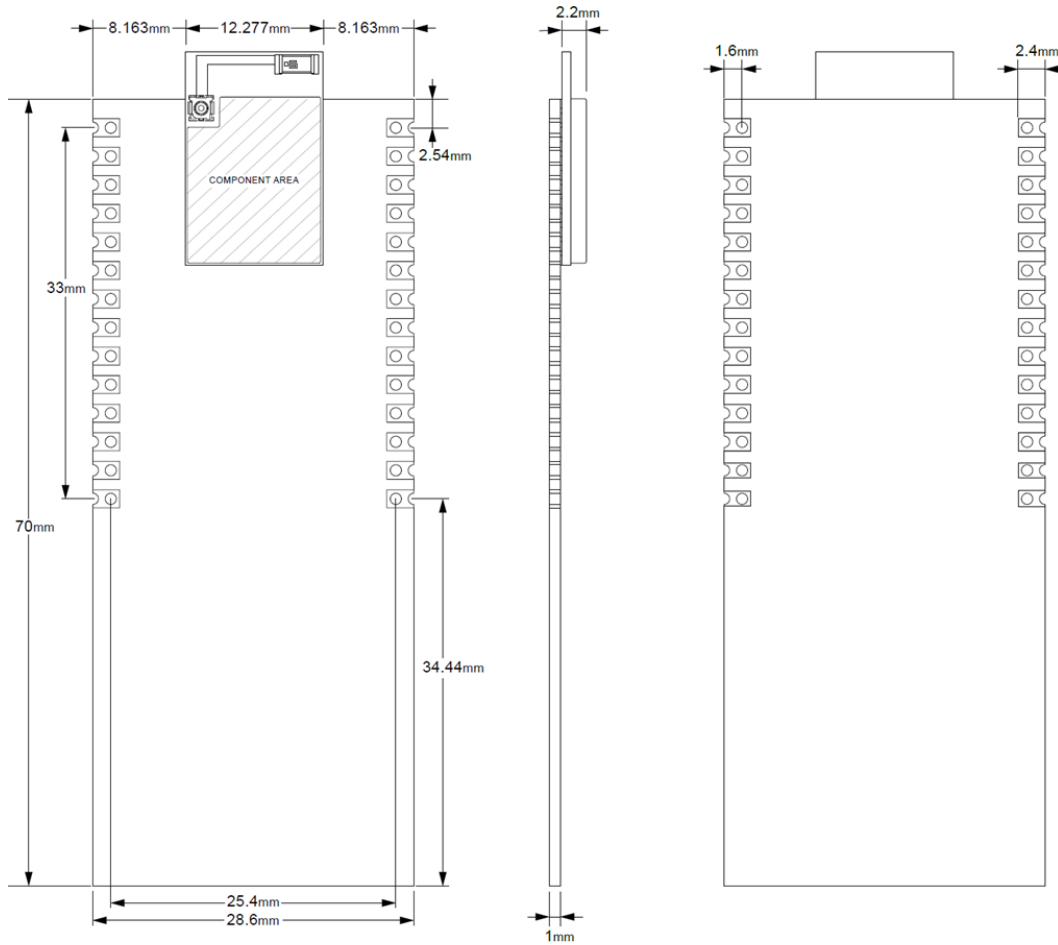

Figure 8: QCC730 Module Development Kit Dimension

Documentation Title	Documentation No	Revision	Classification	Status	Date
Qualcomm QCC730 Module Development Kit User Manual	V2.0	Public	Release		Mar 31, 2024

3.6 Schematic

The DevKit schematic is shown below:

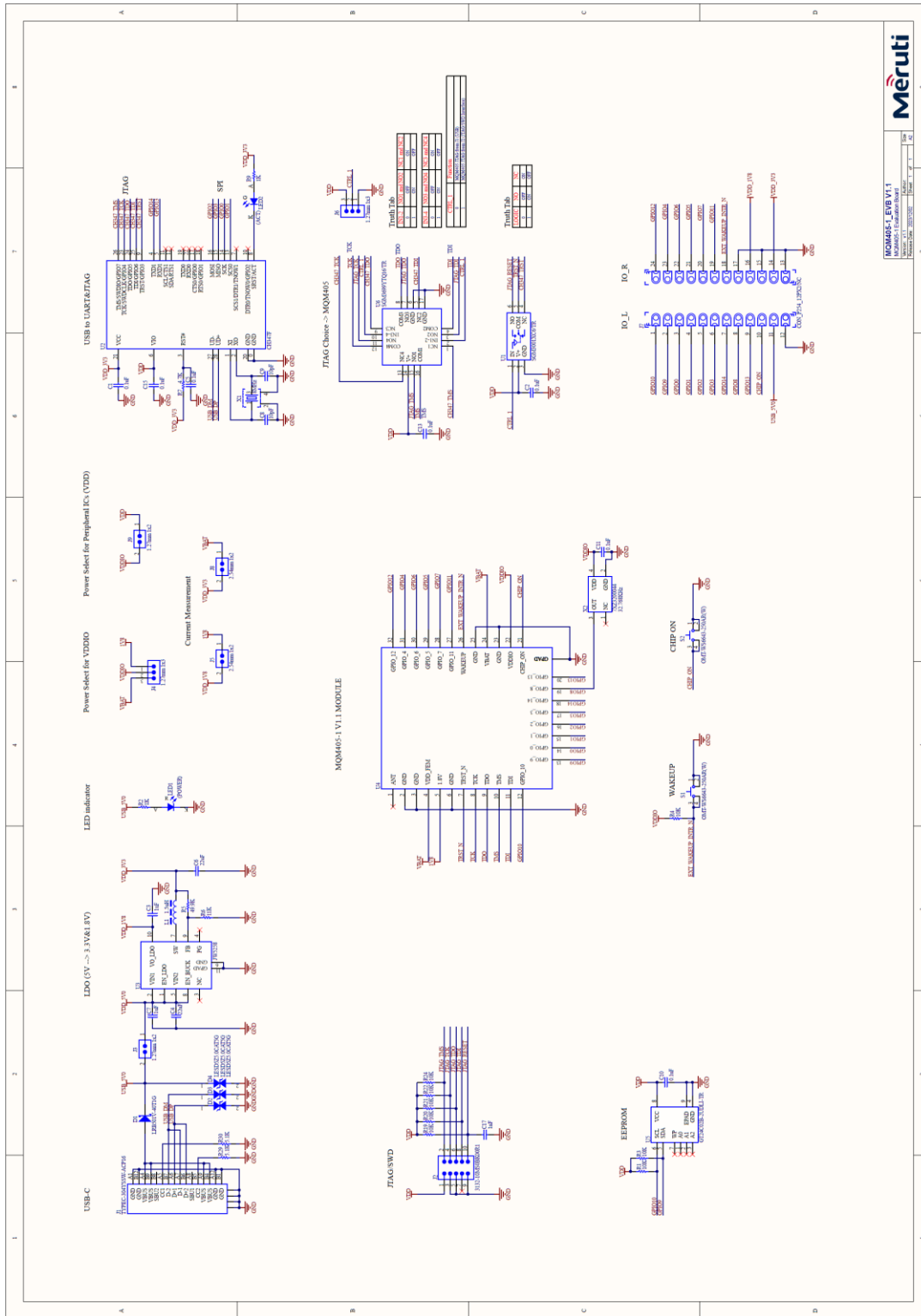

Figure 9: QCC730 Module Development Kit Schematic

Documentation Title	Documentation No	Revision	Classification	Status	Date
Qualcomm QCC730 Module Development Kit User Manual		V2.0	Public	Release	Mar 31, 2024

4 Software

The DevKit software SDK architecture is shown below. The dot line blocks will be provided in the form of binary while FreeRTOS and all upper layer stack and middleware like Matter over Wi-Fi and AWS IoT will be open sourced.

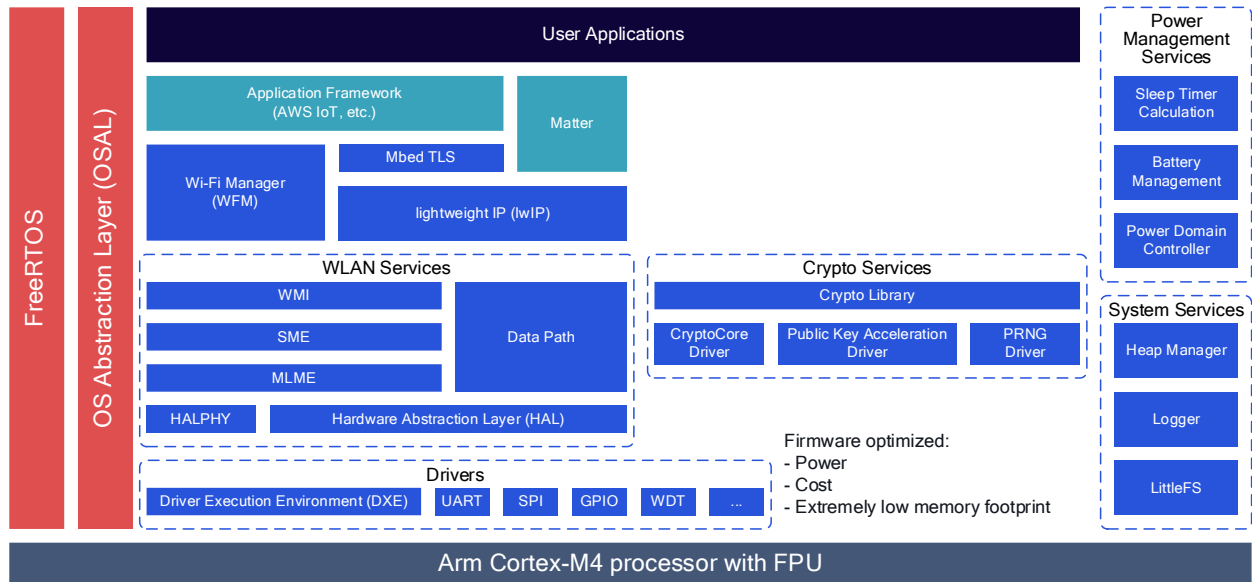

Figure 10: QCC730 Module Development Kit SDK Software Architecture

The software SDK can be available at CodeLinaro: <https://www.codelinaro.org/>

Documentation Title	Documentation No	Revision	Classification	Status	Date
Qualcomm QCC730 Module Development Kit User Manual		V2.0	Public	Release	Mar 31, 2024

5 Integrated Development Environment (IDE)

The DevKit leverages Microsoft Visual Studio Code (“VS Code”) for its integrated development environment (IDE). The VS Code market extension (to be available free on GitHub soon) is developed to customize VS Code for Qualcomm QCC730.

5.1 Microsoft Visual Studio Code (VS Code)

Microsoft Visual Studio Code is widely adopted Integrated Development Environment (IDE) embraced by developer community. It becomes an ad-hoc standard IDE lately. VS Code can be downloaded from:

VS Code: <https://code.visualstudio.com/docs/?dv=win>

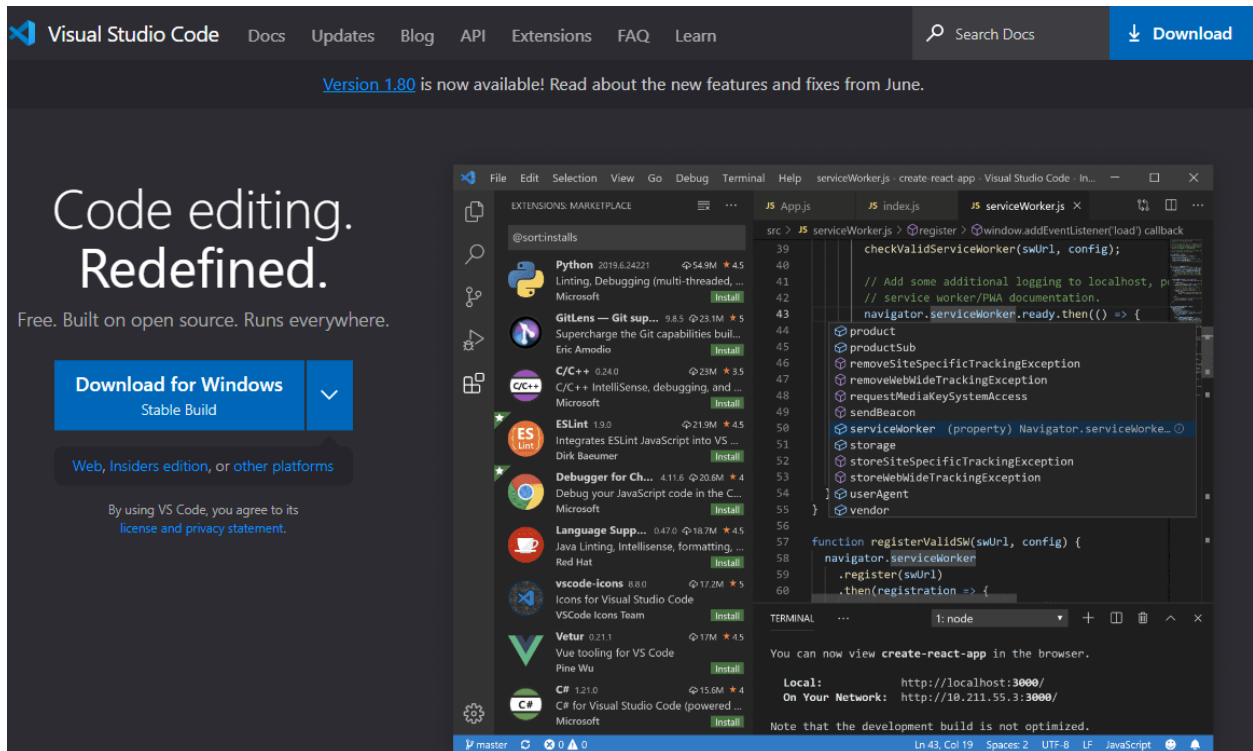

Figure 11: Microsoft Visual Studio Code Download

5.2 VS Code IDE Functional Description

With VS Code, developers can complete all application software development inside this IDE, including:

Edit/Build/Flash

- Build and flash bin
- Build parameter config
- Console port
- Code editor

Debug Target

- Breakpoint

Documentation Title	Documentation No	Revision	Classification	Status	Date
Qualcomm QCC730 Module Development Kit User Manual		V2.0	Public	Release	Mar 31, 2024

- Back trace
- Step in/out
- Step over
- Local variable, argument variable, and register watch
- Add variable to watch
- Reset debug
- Pause debug
- Stop debug
- Read memory

Project

- Create new project from example
- Download SDK
- Auto configure Build & debug environment

The DevKit VS Code IDE architecture is shown below:

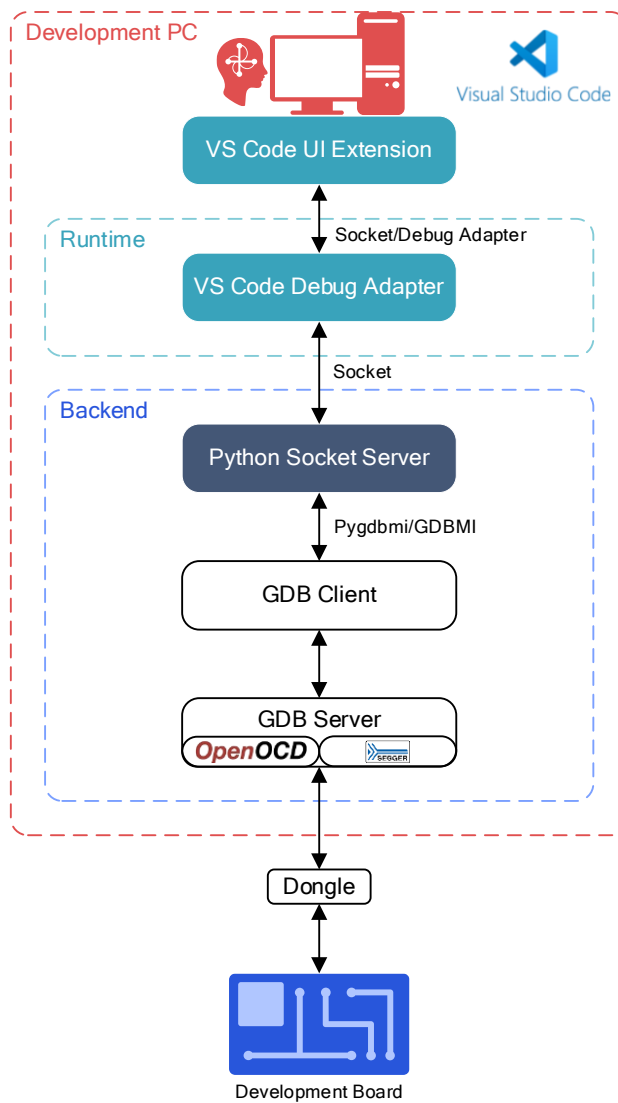

Figure 12: QCC730 Module Development Kit VS Code IDE Architecture

Documentation Title	Documentation No	Revision	Classification	Status	Date
Qualcomm QCC730 Module Development Kit User Manual		V2.0	Public	Release	Mar 31, 2024

6 Order Information

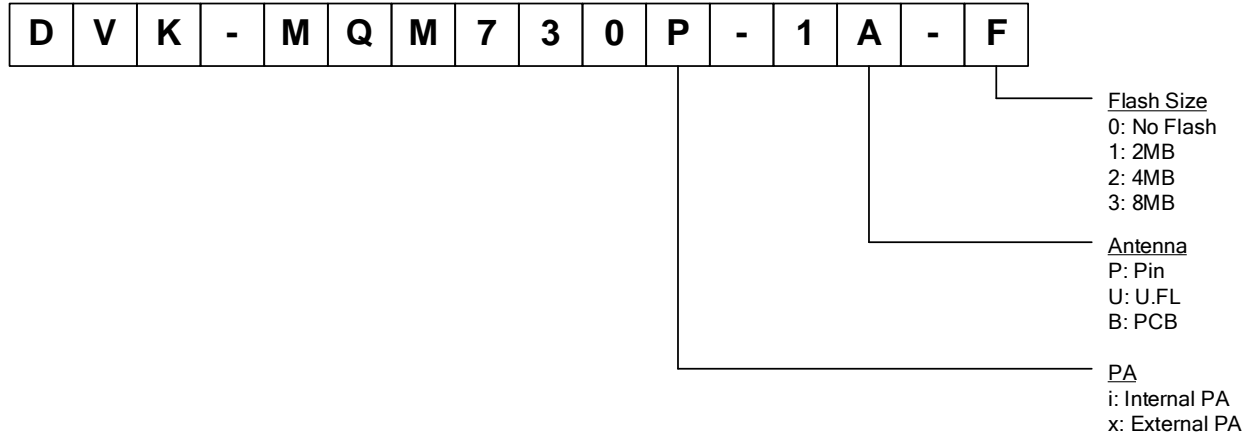

Figure 13: Order Number

Documentation Title	Documentation No	Revision	Classification	Status	Date
Qualcomm QCC730 Module Development Kit User Manual		V2.0	Public	Release	Mar 31, 2024

7 Where to Buy

The DevKit can be available from the following retailers:

Retailer	Region	Website
Codico	Europe	www.codico.com
OKdo	Europe, USA	www.okdo.com
Excelpoint	SE Asia, USA	www.excelpoint.com
SeedStudio	Global	www.seeedstudio.cc

Documentation Title	Documentation No	Revision	Classification	Status	Date
Qualcomm QCC730 Module Development Kit User Manual		V2.0	Public	Release	Mar 31, 2024

Revision History

Revision	Description	Date
0.1	Initial draft	January 5, 2024
0.2	Changed module model name to MQM730-1	January 20, 2024
2.0	Re-designed to optimize RF performance	March 31, 2024

Documentation Title	Documentation No	Revision	Classification	Status	Date
Qualcomm QCC730 Module Development Kit User Manual		V2.0	Public	Release	Mar 31, 2024

Disclaimer and Copyright Notice

Information in this document, including URL references, is subject to change without notice. Please visit www.meruti.io/ for the latest information.

THIS DOCUMENT IS PROVIDED AS IS WITH NO WARRANTIES WHATSOEVER, INCLUDING ANY WARRANTY OF MERCHANTABILITY, NON-INFRINGEMENT, FITNESS FOR ANY PARTICULAR PURPOSE, OR ANY WARRANTY OTHERWISE ARISING OUT OF ANY PROPOSAL, SPECIFICATION OR SAMPLE.

All liability, including liability for infringement of any proprietary rights, relating to the use of information in this document, is disclaimed. No licenses express or implied, by estoppel or otherwise, to any intellectual property rights are granted herein.

The Wi-Fi Alliance Member logo is a trademark of the Wi-Fi Alliance. The Bluetooth logo is a registered trademark of Bluetooth SIG. All trade names, trademarks and registered trademarks mentioned in this document are property of their respective owners and are hereby acknowledged.

Copyright©2024 Meruti Design, inc. All rights reserved.