

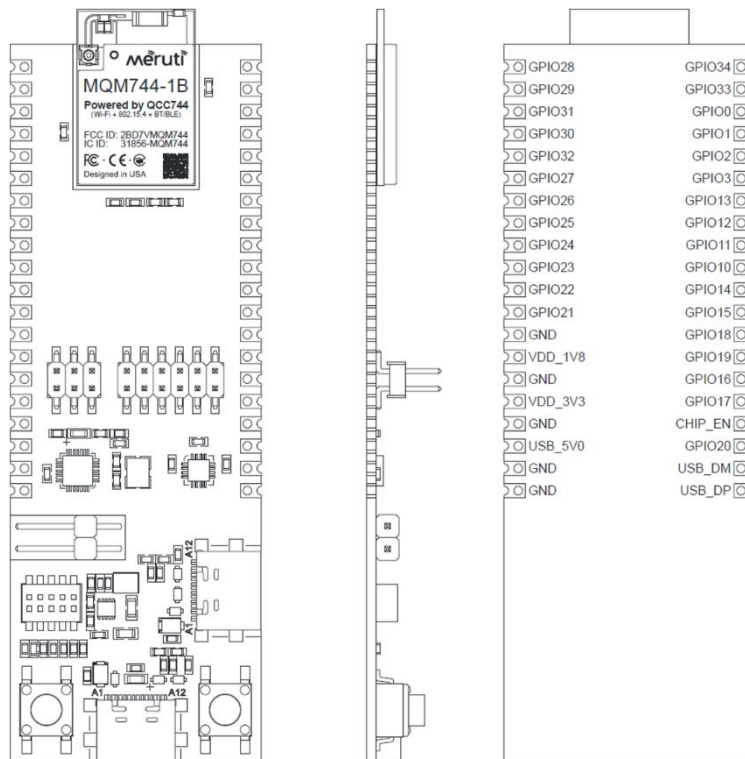

Qualcomm QCC744 Module Development Kit

March 2024



Documentation Title	Documentation No	Revision	Classification	Status	Date
Qualcomm QCC744 Module Development Kit User Manual		V2.0	Public	Release	Nar 31, 2024

Table of Contents

1	Overview	3
2	Package	4
3	Hardware	5
3.1	Block Diagram	5
3.2	Functional Description	5
3.2.1	Power Supply	5
3.2.2	Power Measurement	5
3.2.3	Debug	5
3.2.4	Reset and Boot	6
3.2.5	Headers	6
3.2.6	Pin Definition	7
3.3	Component Layout	8
3.4	Jumper Setting	8
3.5	Mechanical Dimension	9
3.6	Schematic	11
4	Software	12
5	Integrated Development Environment (IDE)	13
5.1	Microsoft Visual Studio Code (VS Code)	13
5.2	VS Code IDE Functional Description	13
6	Order Information	15
7	Where to Buy	16

Documentation Title	Documentation No	Revision	Classification	Status	Date
Qualcomm QCC744 Module Development Kit User Manual		V2.0	Public	Release	Nar 31, 2024

1 Overview

Powered by Qualcomm QCC744, Qualcomm QCC744 Module Development Kit (“DevKit”) is purposely-designed for application software developers with developer first mindset. The DevKit exposes all QCC744 GPIO pins via QCC744 module to dual 2.54mm (0.1inch) headers to allow flexible expansion. Developers can easily add sensors and other accessories through these dual headers. The dual header is designed to have width of 25.4mm (1.0inch) to allow easy plug-in to the widely used breadboard further to facilitate prototyping development.

The QR code is provided on the back of the DevKit to allow developers to obtain this user manual online.



Figure 1: QCC744 Module Development Kit QR Code

The DevKit 3-side view is shown below:

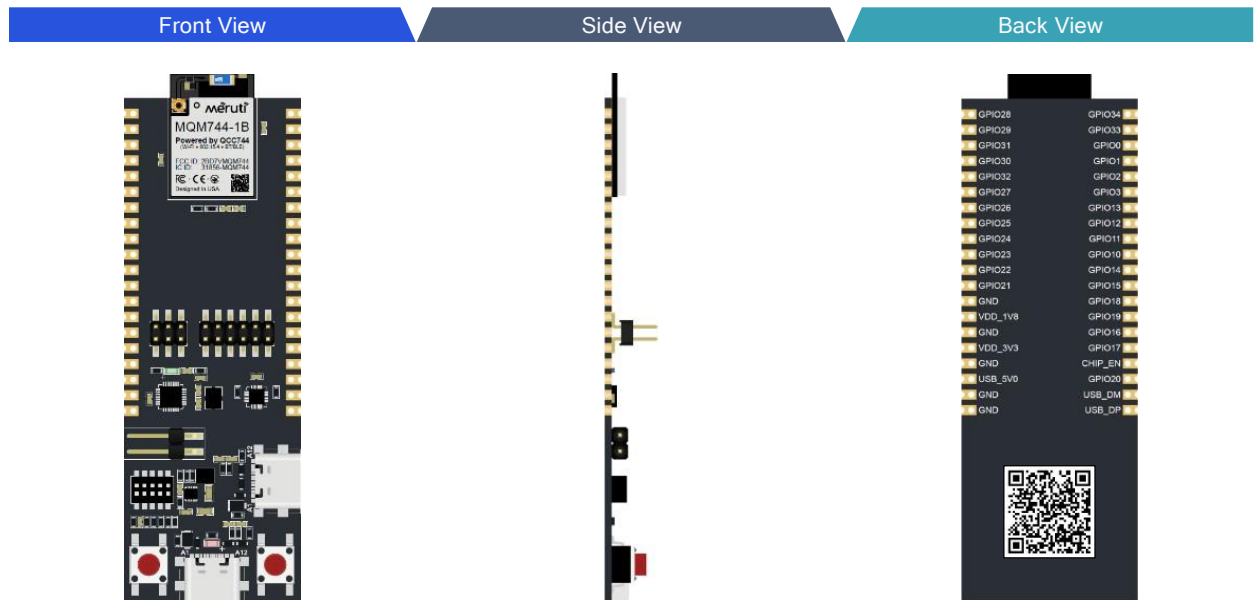

Figure 2: QCC744 Module Development Kit View

Documentation Title	Documentation No	Revision	Classification	Status	Date
Qualcomm QCC744 Module Development Kit User Manual		V2.0	Public	Release	Nar 31, 2024

2 Package

Included with the DevKit are a pair of male and a pair of female headers to allow developers to have flexibility to mate into their expansion boards.

The DevKit package content is shown below:

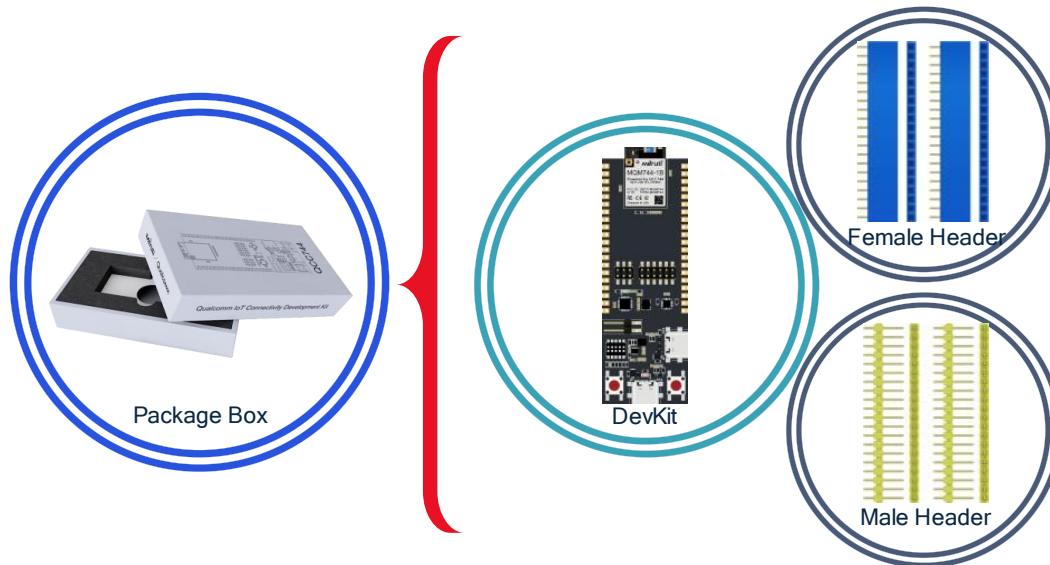

Figure 3: QCC744 Module Development Kit Package

Documentation Title	Documentation No	Revision	Classification	Status	Date
Qualcomm QCC744 Module Development Kit User Manual		V2.0	Public	Release	Nar 31, 2024

3 Hardware

3.1 Block Diagram

The DevKit block diagram is shown below:

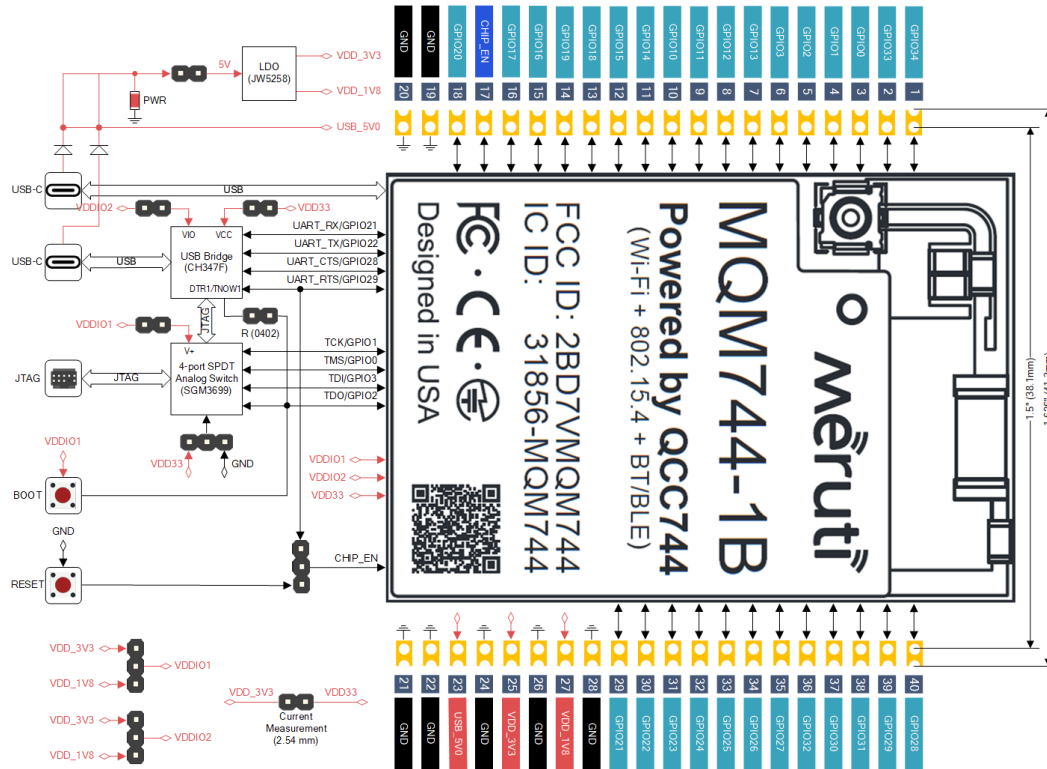

Figure 4: QCC744 Module Development Kit Block Diagram

3.2 Functional Description

3.2.1 Power Supply

The DevKit can be powered from USB-C by plugging into PC. The on-board LDO can convert USB-C 5V into 3.3V and 1.8V. The DevKit input and I/O voltage can be selected from either 3.3V or 1.8V. These 3.3V and 1.8V are also pulled to the DevKit header pins to power expansion boards attached to the DevKit.

The DevKit can also be powered from battery pack which can be plugged into the DevKit headers. The power from USB-C can be de-selected removing the jumper. The battery pack power can be supplied through VDD_3V3 and VDD-18V on the DevKit headers.

3.2.2 Power Measurement

QCC744 module power consumption can be measured through the on-board jumper by connecting to an external current measurement device.

3.2.3 Debug

Documentation Title	Documentation No	Revision	Classification	Status	Date
Qualcomm QCC744 Module Development Kit User Manual		V2.0	Public	Release	Nar 31, 2024

The DevKit supports SEGGER J-Link and OpenOCD. The on-board analog switch allows to developers to choose QCC744 module JTAG to go through SEGGER J-Link or thru USB-C connected to PC. The on-board USB to UART/JTAG bridge allows both JTAG and UART populated on the PC device manager. Developers can use OpenOCD and UART simultaneously.

3.2.4 Reset and Boot

Two buttons are placed on the DevKit with one for software RESET while the other is for BOOT. The headers (J10, J11) is created to allow developers to choose either SW or HW reset/boot.

3.2.5 Headers

Dual standard 2.54mm (0.1inch) headers with 20-pin each side is created on the DevKit to allow developers to attach to any expansion boards of their choice.

The pin map is shown below:

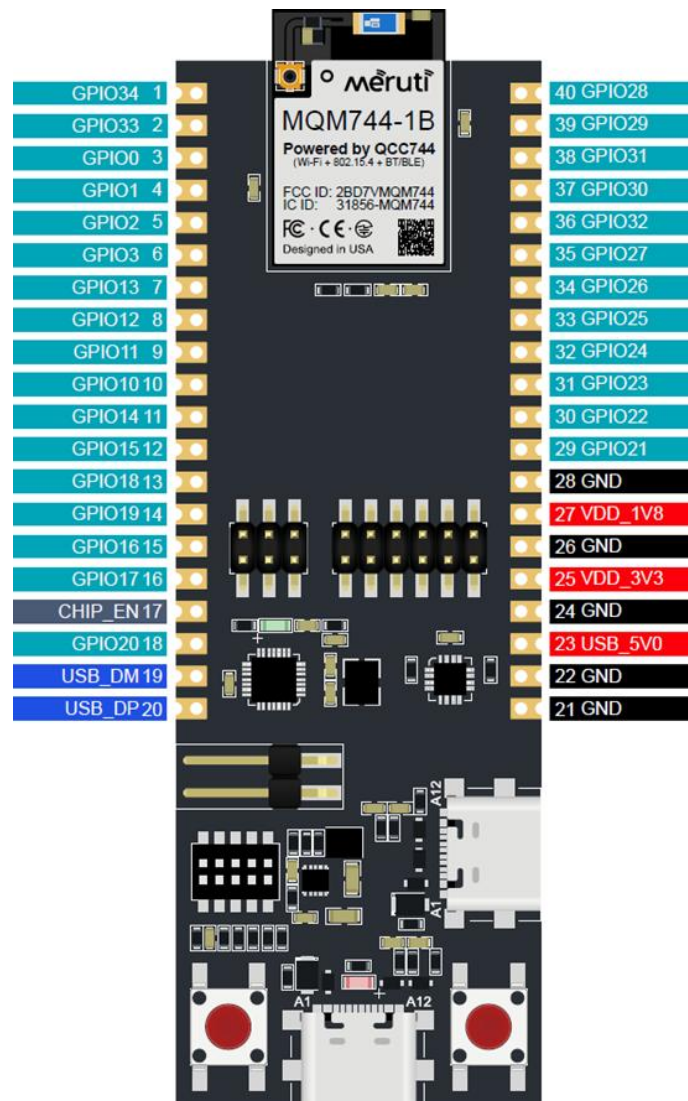

Figure 5: QCC744 Module Development Kit Pin Map

Documentation Title	Documentation No	Revision	Classification	Status	Date
Qualcomm QCC744 Module Development Kit User Manual		V2.0	Public	Release	Nar 31, 2024

3.2.6 Pin Definition

Pin	Pin Name	Type	Power Domain	Description
23	VDD_5V0	PWR	-	5.0V from USB-C
25	VDD_3V3	PWR	-	3.3V from on-board LDO or external battery
27	VDD_1V8	PWR	-	1.8V from on-board LDO or external battery
19,20,21,22, 24,26,28	GND	GND	-	Ground
17	CHIP_EN	DI	-	Chip power on
3	GPIO0	DI/DO	VDDIO1	Generic PIO
4	GPIO1	DI/DO	VDDIO1	Generic PIO
5	GPIO2	DI/DO	VDDIO1	Generic PIO
6	GPIO3	DI/DO	VDDIO1	Generic PIO
10	GPIO10	DI/DO	VDDIO1	Generic PIO
9	GPIO11	DI/DO	VDDIO1	Generic PIO
8	GPIO12	DI/DO	VDDIO1	Generic PIO
7	GPIO13	DI/DO	VDDIO1	Generic PIO
11	GPIO14	DI/DO	VDDIO1	Generic PIO
12	GPIO15	DI/DO	VDDIO1	Generic PIO
15	GPIO16	DI/DO	VDD33	Generic PIO
16	GPIO17	DI/DO	VDD33	Generic PIO
13	GPIO18	DI/DO	VDD33	Generic PIO
14	GPIO19	DI/DO	VDD33	Generic PIO
18	GPIO20	DI/DO	VDDIO2	Generic PIO
29	GPIO21	DI/DO	VDDIO2	Generic PIO
30	GPIO22	DI/DO	VDDIO2	Generic PIO
31	GPIO23	DI/DO	VDDIO2	Generic PIO
32	GPIO24	DI/DO	VDDIO2	Generic PIO
33	GPIO25	DI/DO	VDDIO2	Generic PIO
34	GPIO26	DI/DO	VDDIO2	Generic PIO
35	GPIO27	DI/DO	VDDIO2	Generic PIO
40	GPIO28	DI/DO	VDDIO2	Generic PIO
39	GPIO29	DI/DO	VDDIO2	Generic PIO
37	GPIO30	DI/DO	VDDIO2	Generic PIO
38	GPIO31	DI/DO	VDDIO2	Generic PIO

Documentation Title	Documentation No	Revision	Classification	Status	Date
Qualcomm QCC744 Module Development Kit User Manual	V2.0	Public	Release	Nar 31, 2024	

36	GPIO32	DI/DO	VDDIO2	Generic PIO
2	GPIO33	DI/DO	VDDIO2	Generic PIO
1	GPIO34	DI/DO	VDDIO2	Generic PIO

3.3 Component Layout

Jumpers and button are purposely designed and defined to allow flexible configurations and operations . The DevKit component layout is illustrated below:

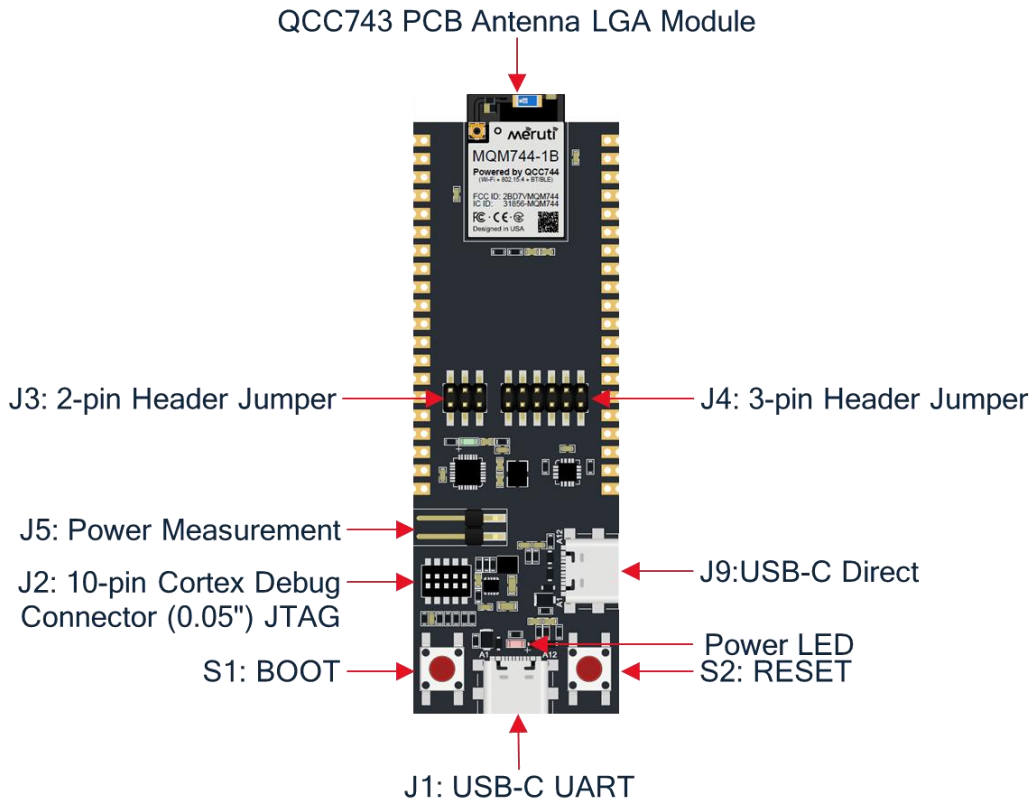

Figure 6: QCC744 Module Development Kit Component Layout

3.4 Jumper Setting

The DevKit jumper settings are illustrated below:

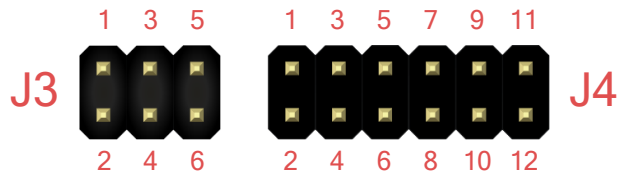

Figure 7: QCC744 Module Development Kit Jumper Setting

Each individual jumper setting is defined in the table below:

Documentation Title	Documentation No	Revision	Classification	Status	Date
Qualcomm QCC744 Module Development Kit User Manual	V2.0	Public	Release	Nar 31, 2024	

Jumper	Pin 1	Pin 2	Description
J3 (2-pin Jumper)	1	2	USB 5V power supply enable
	3	4	USB to UART bridge (CH347F) power-on
	5	6	CH347F DTR1 to GPIO2 connect enable
J4 (3-pin Jumper)	1	3	VDDIO1 selection 1.8V
	3	5	VDDIO1 selection 3.3V
	2	4	VDDIO2 selection 1.8V
	4	6	VDDIO2 selection 3.3V
	7	9	10-pin Cortex debug JTAG
	9	11	USB-C debug OpenOCD
	8	10	Software reset via GPIO29
10	12	Hardware reset via RESEST button	

3.5 Mechanical Dimension

The DevKit mechanical dimension is shown below:

Documentation Title	Documentation No	Revision	Classification	Status	Date
Qualcomm QCC744 Module Development Kit User Manual		V2.0	Public	Release	Nar 31, 2024

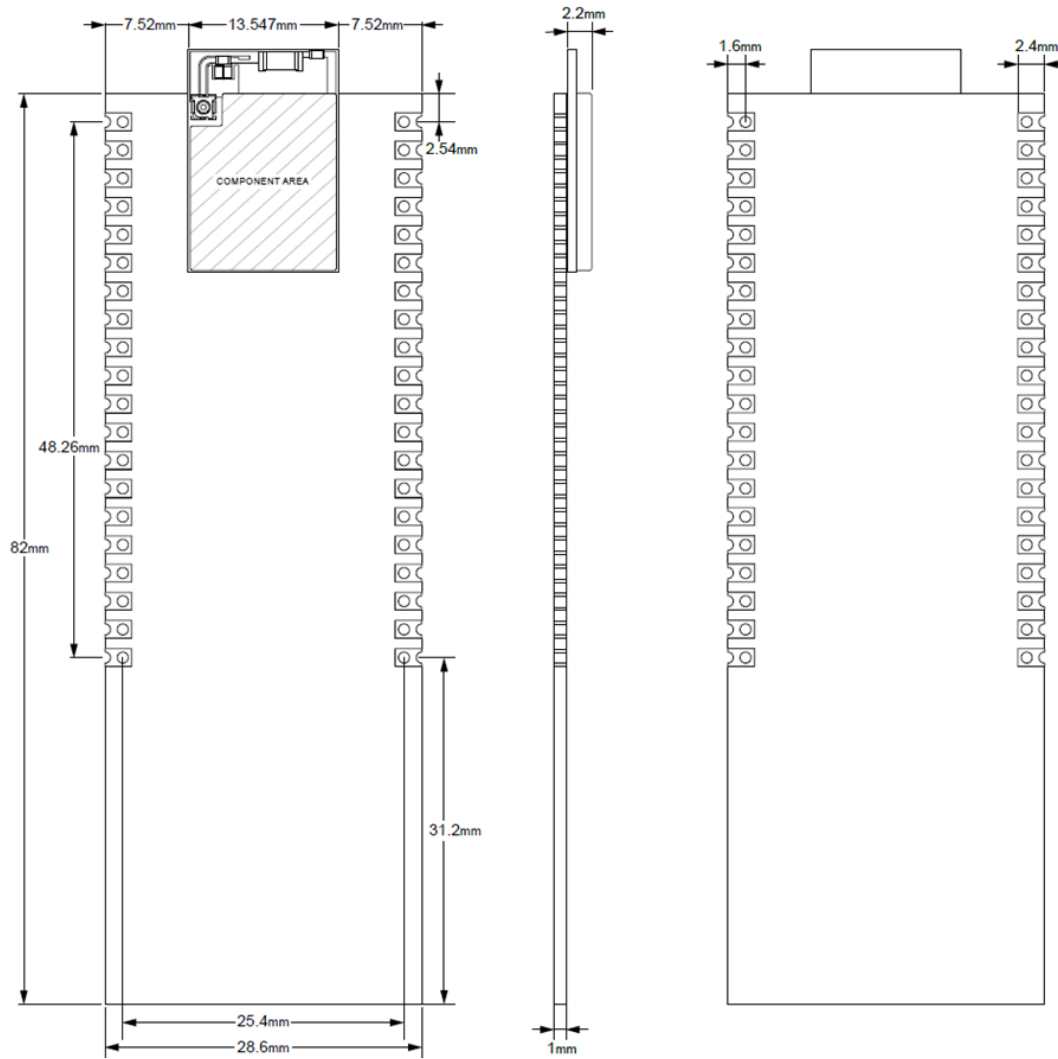

Figure 8: QCC744 Module Development Kit Dimension

Documentation Title	Documentation No	Revision	Classification	Status	Date
Qualcomm QCC744 Module Development Kit User Manual		V2.0	Public	Release	Nar 31, 2024

3.6 Schematic

The DevKit schematic is shown below:

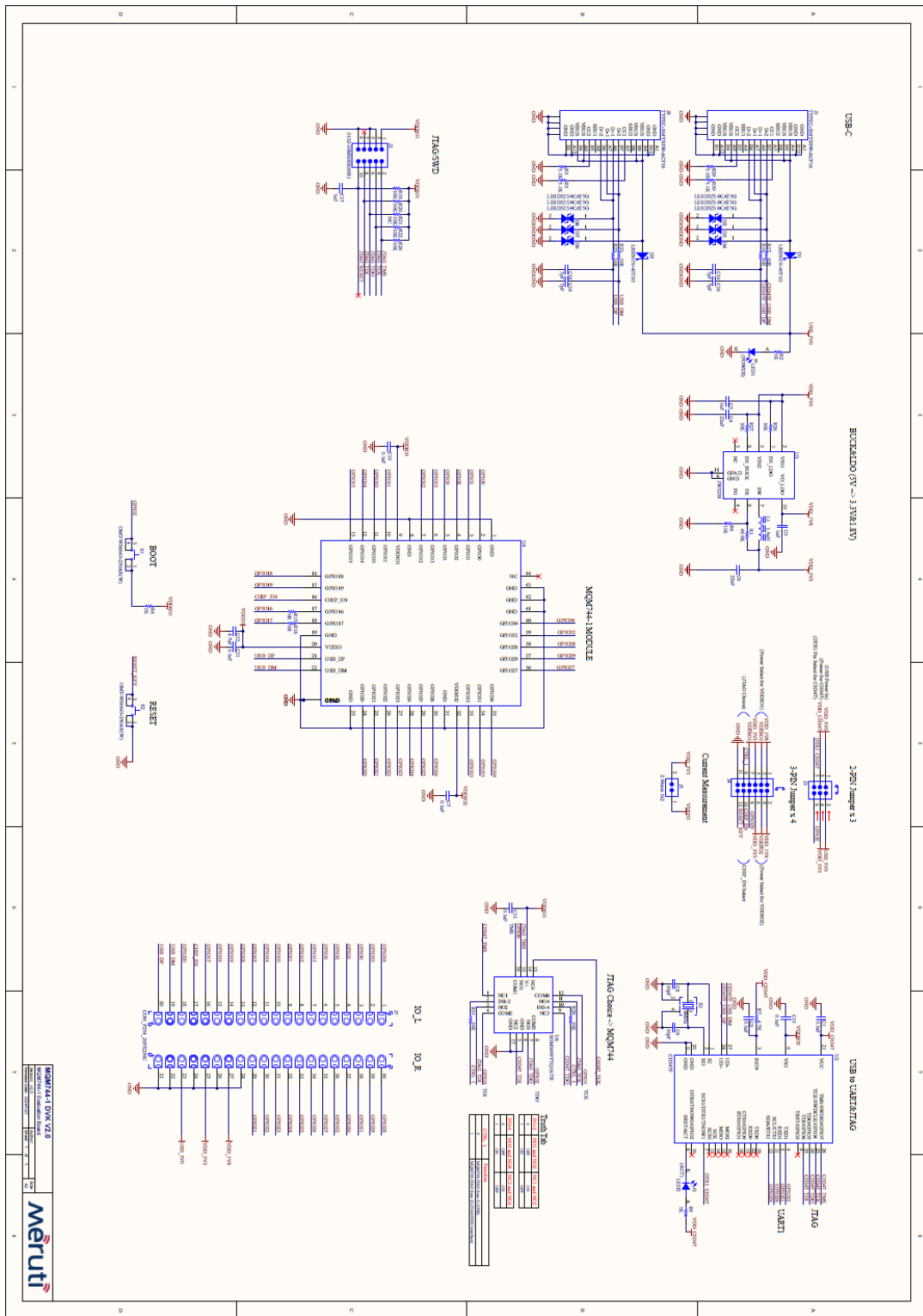

Figure 9: QCC744 Module Development Kit Schematic

Documentation Title	Documentation No	Revision	Classification	Status	Date
Qualcomm QCC744 Module Development Kit User Manual		V2.0	Public	Release	Nar 31, 2024

4 Software

The DevKit software SDK architecture is shown below. The grey blocks will be provided in the form of binary while FreeRTOS and all upper layer stacks and middleware like Matter over Wi-Fi and AWS IoT will be open sourced.

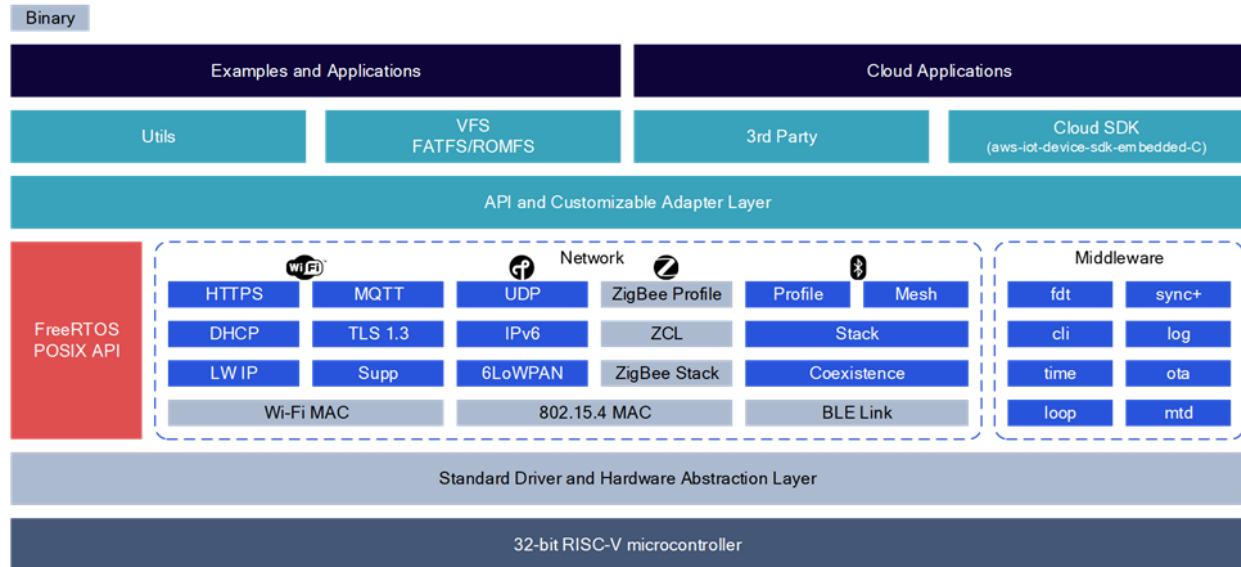

Figure 10: QCC744 Module Development Kit SDK Software Architecture

The software SDK can be available at Codelinaro: <https://git.codelinaro.org/clo/qcc7xx/QCCSDK-QCC74x>

Documentation Title	Documentation No	Revision	Classification	Status	Date
Qualcomm QCC744 Module Development Kit User Manual		V2.0	Public	Release	Nar 31, 2024

5 Integrated Development Environment (IDE)

The DevKit leverages Microsoft Visual Studio Code (“VS Code”) for its integrated development environment (IDE). The VS Code market extension (to be available free on GitHub soon) is developed to customize VS Code for Qualcomm QCC744.

5.1 Microsoft Visual Studio Code (VS Code)

Microsoft Visual Studio Code is widely adopted Integrated Development Environment (IDE) embraced by developer community. It becomes an ad-hoc standard IDE lately. VS Code can be downloaded from:

VS Code: <https://code.visualstudio.com/docs/?dv=win>

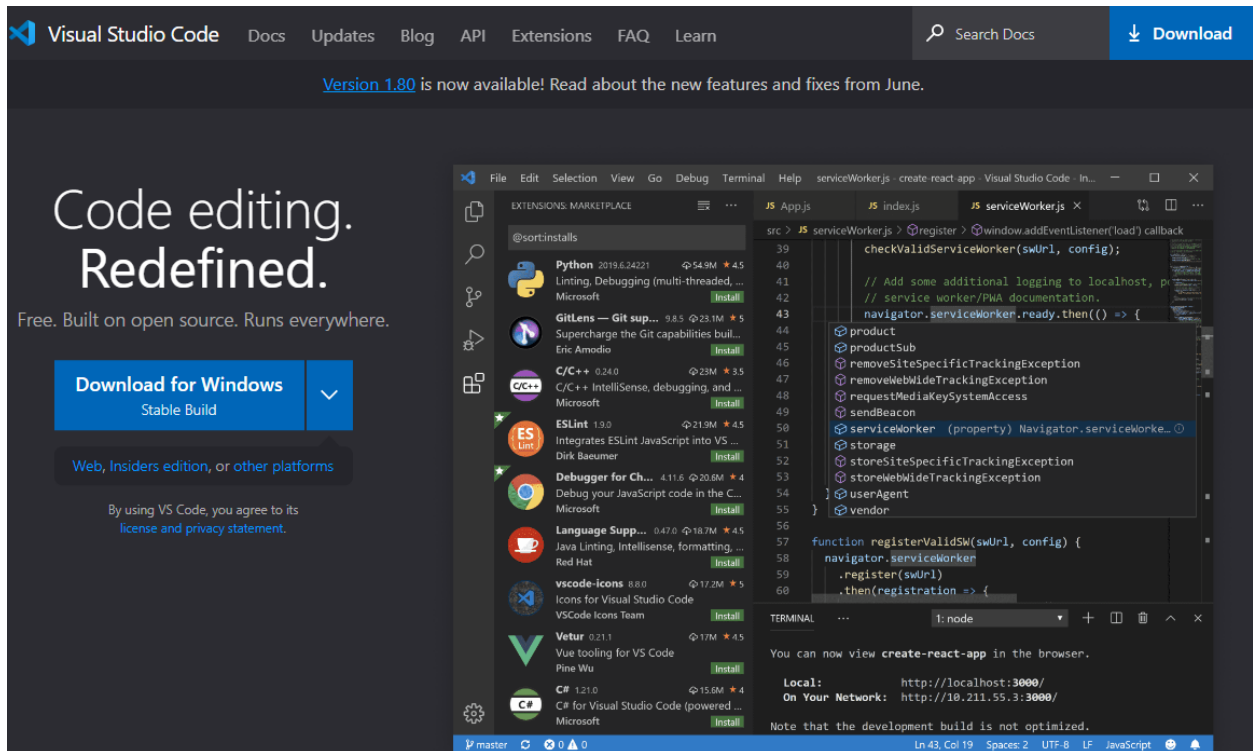

Figure 11: Microsoft Visual Studio Code Download

5.2 VS Code IDE Functional Description

With VS Code, developers can complete all application software development inside this IDE, including:

Edit/Build/Flash

- Build and flash bin
- Build parameter config
- Console port
- Code editor

Debug Target

- Breakpoint

Documentation Title	Documentation No	Revision	Classification	Status	Date
Qualcomm QCC744 Module Development Kit User Manual		V2.0	Public	Release	Nar 31, 2024

- Back trace
- Step in/out
- Step over
- Local variable, argument variable, and register watch
- Add variable to watch
- Reset debug
- Pause debug
- Stop debug
- Read memory

Project

- Create new project from example
- Download SDK
- Auto configure Build & debug environment

The DevKit VS Code IDE architecture is shown below:

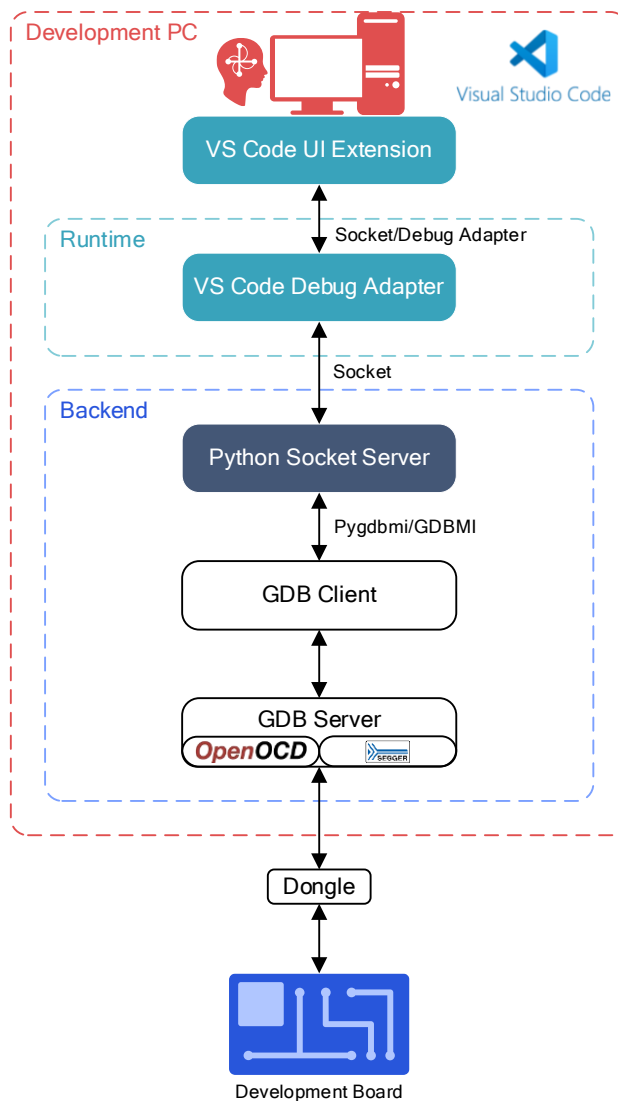

Figure 12: QCC744 Module Development Kit VS Code IDE Architecture

Documentation Title	Documentation No	Revision	Classification	Status	Date
Qualcomm QCC744 Module Development Kit User Manual		V2.0	Public	Release	Nar 31, 2024

6 Order Information

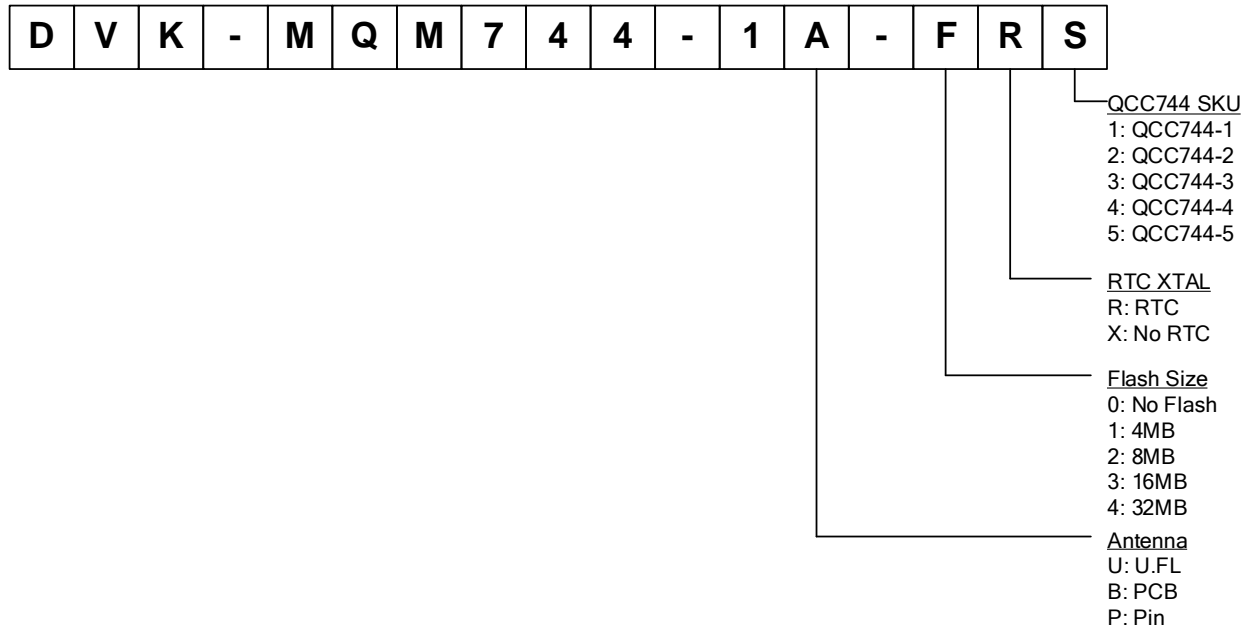

Figure 13: Order Number

Documentation Title	Documentation No	Revision	Classification	Status	Date
Qualcomm QCC744 Module Development Kit User Manual		V2.0	Public	Release	Nar 31, 2024

7 Where to Buy

The DevKit can be available from the following retailers:

Retailer	Region	Website
Codico	Europe	www.codico.com
OKdo	Europe, USA	www.okdo.com
Excelpoint	SE Asia, USA	www.excelpoint.com
SeedStudio	Global	www.seeedstudio.cc

Documentation Title	Documentation No	Revision	Classification	Status	Date
Qualcomm QCC744 Module Development Kit User Manual		V2.0	Public	Release	Nar 31, 2024

Revision History

Revision	Description	Date
0.1	Initial draft	January 5, 2024
0.2	Miscellaneous error correction	January 15, 2024
0.3	Changed module model name to MQM744-1	January 20, 2024
2.0	Re-designed to optimize RF performance	March 31, 2024

Documentation Title	Documentation No	Revision	Classification	Status	Date
Qualcomm QCC744 Module Development Kit User Manual		V2.0	Public	Release	Nar 31, 2024

Disclaimer and Copyright Notice

Information in this document, including URL references, is subject to change without notice. Please visit www.meruti.io/ for the latest information.

THIS CODUMENT IS PROVIDED AS IS WITH NO WARRANTIES WHATSOEVER, INCLUDING ANY WARRANTY OF MERCHANTABILITY, NON-INFRINGEMENT, FITNESS FOR ANY PARTICULAR PURPOSE, OR ANY WARRANTY OTHERWISE ARISING OUT OF ANY PROPOSAL, SPECIFICATION OR SAMPLE.

All liability, including liability for infringement of any proprietary rights, relating to the use of information in this document, is disclaimed. No licenses express or implied, by estoppel or otherwise, to any intellectual property rights are granted herein.

The Wi-Fi Alliance Member logo is a trademark of the Wi-Fi Alliance. The Bluetooth logo is a registered trademark of Bluetooth SIG. All trade names, trademarks and registered trademarks mentioned in this document are property of their respective owners and are hereby acknowledged.

Copyright©2024 Meruti Design, inc. All rights reserved.